



AIRCRAFT DIFFERENTIAL PRESSURE TRANSDUCER

APT-51HL-1000 Differential (100mV Output)

APTE-51HL-1000 Differential (5V Output)

- Developed For Use With High Line Pressure Compared To Low Differential Pressure
- Ideal For Measuring Pressure Drop Across Filters To Monitor Filter Clogging
- High Natural Frequencies
- Unprecedented Stability And Reliability To High Temperatures (Ruggedized Internal Construction)
- Leakproof, All Welded Construction (No Leak After Exposure To 2000°F 1093°C)
- Utmost In Safety (Secondary Containment Of Pressure Media)
- Fully Qualified (Passed Extensive Environmental Tests, RTCA/DO-160F)
- FAA Manufacturer's Maintenance Facility

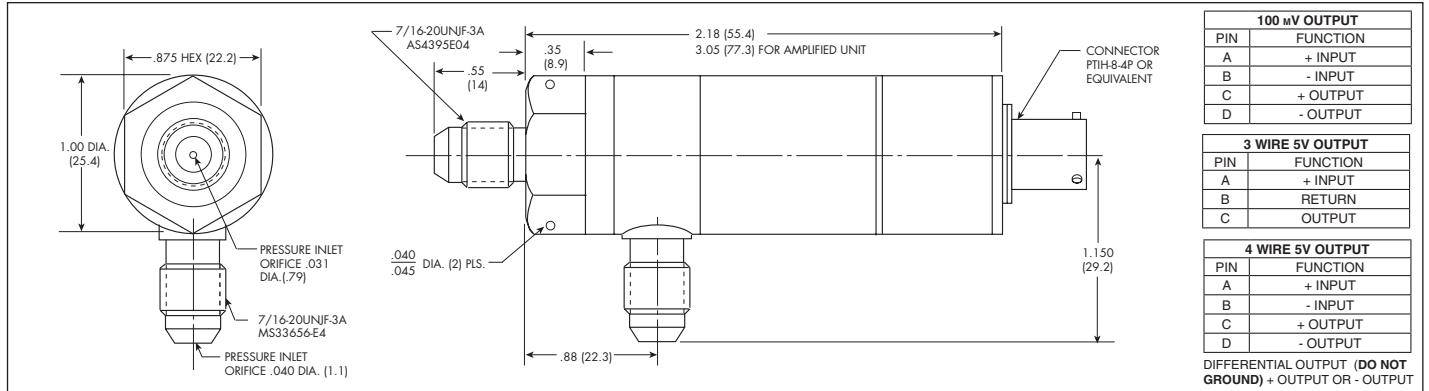
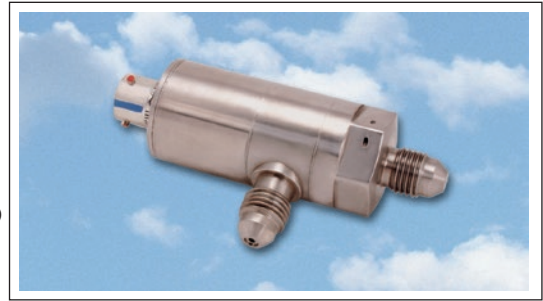

SPECIFICATIONS	UNAMPLIFIED APT-SERIES	AMPLIFIED APTE SERIES
Excitation	10VDC Regulated	28VDC ± 4V
Output	100mV (Typ.)	5VDC Diff. or Single Ended
Power Consumption	100mW (Typ.)	280mW (Typ.)
Input Impedance	1000 Ohms (Min.)	N/A
Output Impedance	2000 Ohms (Max.)	100 Ohms (Max.)
Operating Temperature Range	-65°F to +300°F (-55°C to +150°C)	-65°F to +250°F (-55°C to +120°C)
Weight	0.45 Lb. (Max.)	0.6 Lb. (Max.)
Case Outline	Case Length May Vary With Range, Measuring Mode, Pressure Port and Connector	
Construction Materials	316 SS And 17-4 PH SS	
Pressure Range	To Specification 0-5 PSI to 0-1000 PSI (0-0.35 BAR to 0-70 BAR) (Typ.)	
Line Pressure	10 Times Scale Range, 2000 PSI (Max.)	
Proof Pressure	2 Times Rated Pressure Range, 1000 PSID (Max.)	
Burst Pressure	5 Times Rated Pressure Range, 1000 PSID (Max.)	
Insulation Resistance	100 Megohms Min. @ 50VDC	
Mounting Torque	75 Inch-Pounds (Max.)	
Total Error Band	± 2% FSO From 32°F (0°C) to 185°F (85°C), Increasing to ± 3% FSO at -65°F (-55°C) and +250°F (120°C), The APT Maintains ± 3% FSO to 300°F (150°C)	
Resolution	Infinitesimal	
MTBF	At Least 30,000 Hours	
Fluid Temperature	-65°F to +300°F (-55°C to +150°C)	
Storage Temperature Range (Non Operating)	-65°F to +185°F (-55°C to +85°C)	
Altitude-Operating	Up To 51,000 Feet	
Media Compatability	Main Port: JP-4 and JP-5 Grade Aviation Turbine Fuel Per MIL-T-5624, Hydraulic Fluid Per MIL-H-5606, MIL-H-83282, Engine and Transmission Lubrication Oil Per MIL-L-7808 and MIL-L-23699 and Aviation Gasoline Per MIL-G-5572 All Grades Reference Port: Clean Dry Gas	
Humidity	100% Relative Humidity	
Acceleration	Operational After Being Subjected to "G" Levels of 12 "G"s Per MIL-STD-810C, Method 513.2 Procedure 1	
Vibration	RTCA/DO-160F, Sec 8, Cat R, D & D1 Random Vibration Curves	
Mechanical Shock	RTCA/DO-160F, Sec 7, Cat B, 20g, 11 msec sawtooth shock	
Electromagnetic Interference	APTE SERIES: Meets RTCA DO-160 Sections 18, 19 and 21 All Cat. A, Section 20 Cat. U. (With Shielded Cable)	
Electrical Spike Protection	APTE SERIES: Unit Satisfies Power Input and Voltage Spike Conducted DO-160 Sections 16 and 17. Power Input Test 16 Voltage Spike Conducted Test 17	

Note: Custom pressure ranges, accuracies and mechanical configurations available. Dimensions are in inches. Dimensions in parenthesis are in millimeters. All dimensions nominal. (B) Continuous development and refinement of our products may result in specification changes without notice. Copyright © 2014 Kulite Semiconductor Products, Inc. All Rights Reserved.

TYPICAL ERROR BAND

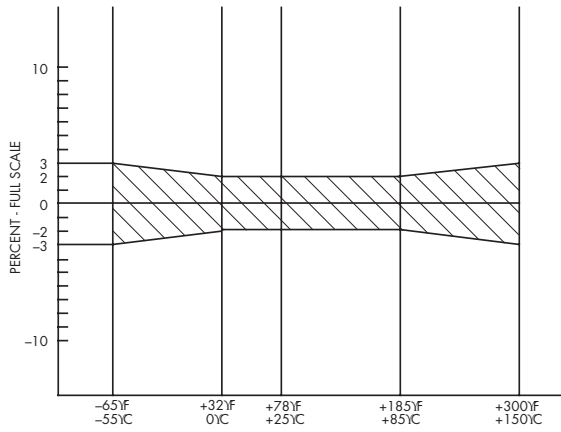

FIG I: TYPICAL ERROR BAND - UNAMPLIFIED UNIT

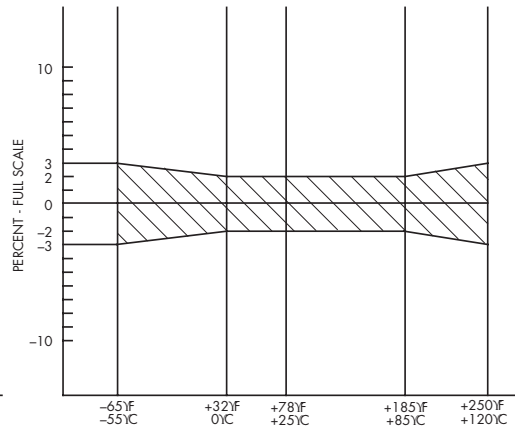
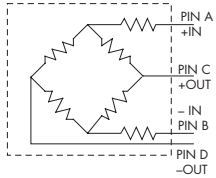

FIG II: TYPICAL ERROR BAND - AMPLIFIED UNIT

NOTE: OTHER TEMPERATURE RANGES AND TIGHTER SPECIFICATIONS ARE AVAILABLE.

WIRING

0 - 100 mV OUTPUT



3 WIRE 0.5 - 5V OUTPUT

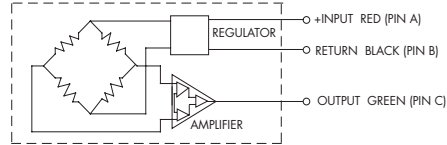

4 WIRE 0 - 5V OUTPUT

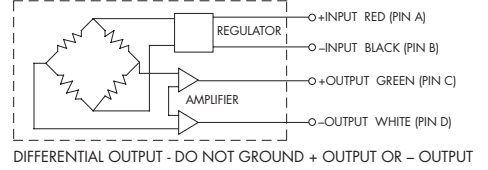

Note: Custom pressure ranges, accuracies and mechanical configurations available. Dimensions are in inches. Dimensions in parenthesis are in millimeters. All dimensions nominal. (B) Continuous development and refinement of our products may result in specification changes without notice. Copyright © 2014 Kulite Semiconductor Products, Inc. All Rights Reserved.