

# Further Work on Acceleration Insensitive Semiconductor Pressure Sensors for High Bandwidth Measurements on Rotating Turbine Blades

A.D. Kurtz<sup>1</sup>, R.W. Ainsworth<sup>2</sup>, S.J. Thorpe<sup>2</sup>, and A. Ned<sup>1</sup>

1

Kulite Semiconductor Inc.  
1 Willow Tree Road,  
Leonia,  
New Jersey,  
U.S.A.

2

Department of Engineering Science,  
Oxford University,  
Parks Road,  
Oxford,  
U.K.

## ABSTRACT

The turbine environment is a harsh one in which to attempt fast response measurements of static pressure on a rotating component, even for model turbines operating at ambient temperatures. Because of the high rotational speed of most turbines, pressure sensors can be exposed to high levels of centrifugal and vibrational acceleration. Indeed, latest experiments have been designed with high vibrational levels of acceleration deliberately introduced to permit the study of aero elastic behavior – the coupling of structural response with aerodynamic excitation.

Semiconductor pressure sensors function by determining the deflection of a small silicon diaphragm under exposure to a normal stress (pressure), using a Wheatstone bridge network of strain gages to measure this movement. However, the diaphragm will also deflect under the influence of centrifugal and vibrational accelerations, and the experimenter must be aware of these effects, and try to take them into account.

In this paper, the design of an acceleration insensitive semiconductor sensor is presented which compensates for these deleterious effects. The construction of the device is described. Finally, latest results from tests to exposure to high levels of centrifugal acceleration are presented, demonstrating the operation of the device in a manner that was intended when it was designed. Potential

applications in the turbo-machinery area are also outlined.

## 1. Introduction

The measurement of pressures in the context of turbo machinery operation has been an important means of investigating the operation of gas turbines since their invention. The drive in recent times has been the accurate measurement of 'unsteady pressure', so that time-varying phenomena can be assessed and taken into account in the design process. In terms of blade aerodynamic profile design, the desire is to measure both total and static quantities on stationary and rotating components to bandwidths of order 1200 kHz. Pressures are required to calculate gas loading on other parts, such as rotor discs, labyrinth seals, de-swirl vanes and the like. In addition to pressures on components, the efficiency of an engine is highly dependent on the orderliness of the air-flow through the machine, and to this end the engineer would like to assess the time-resolved three-dimensional gas flows (yaw and pitch angle, Mach number, total pressure) in all stages of the compression and expansion processes.

Much progress has been made in achieving some of these goals with the semiconductor-based piezoresistive silicon pressure diaphragm. Equally there is continuing interest in improving the applicability of these devices to more challenging measurement applications. The silicon sensor, in addition to being sensitive to

pressure, is also sensitive to temperature, base strain and inertial stresses in the diaphragm material when subjected to accelerations, whether caused by rotation or vibration. Of these, it is the sensitivity to acceleration, which generally has the largest effect. This can be accounted for by way of calibration – the size of a correction can be related to the known acceleration vector. There may however be some applications (for instance in aero elastic work where blades are vibrating in an unquantifiable manner) when is insensitive to acceleration fields. The purpose of the present work is to investigate the feasibility of such a device. First it will be necessary to understand the operation of a conventional piezoresistive sensor.

in turn: the production of a suitable deflecting diaphragm to turn applied stress into displacement, and the addition of piezoresistive strain gage elements to the diaphragm to record the displacement.

Referring to figures 1 and 2, the silicon wafer itself is micro-machined on its rear surface using photolithographic techniques in conjunction with a chemical etch. The purpose of this micro-machining of a non-uniform section enables varying values of surface strain to be achieved in the front face under deflecting conditions, and the sensor designer, using modern three-dimensional finite element techniques determines the optimal placement of the semiconductor strain gages. A sensor with a plan section of .060” by .060” is shown in figures 1, 2, where four individual strain sensors may be observed. These piezoresistive strain gages are connected in serpentine configuration, their positioning is described below. The thickness of the silicon die at its thinnest section is the parameter, which determines the nominal pressure range of the device, all other features remaining invariant. A diaphragm thickness of .0005” at the thinnest section indicated would be required for a full-scale pressure rating of 0.3 bar pressure difference across the diaphragm, rising to .002” for a 1.5 bar differential. An introduction of a stiffening member in the middle of the diaphragm (boss) is used to promote stress-raising features, which in turn yield higher surface strain in the front face of the die. The piezoresistive strain elements are strategically placed with respect to the high strain areas, as indicated in figure 2. In terms of diaphragm shape, rectangular diaphragm designs have largely replaced the earlier circular versions, the precise placement of linear gage elements at stress concentration features being easier in the case of the former.

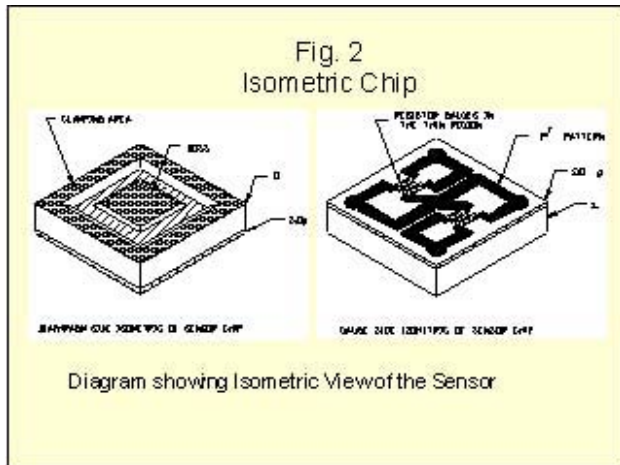
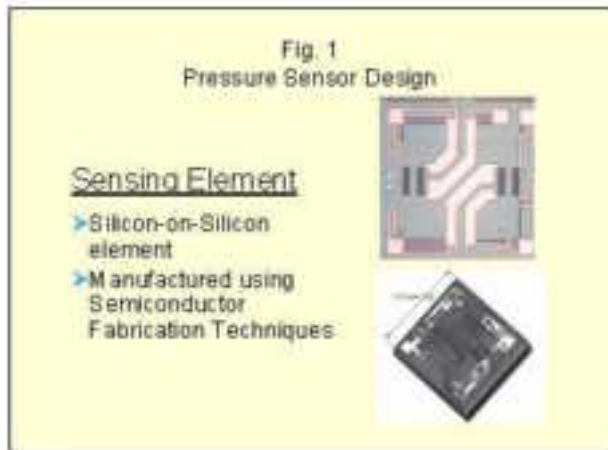

## 2. Piezoresistive (SOI) Pressure Sensor Technology

There are two core elements of the current generation of devices which will be considered

The latest evolution of the patented Silicon on Insulator (SOI) Technology enables the piezoresistive sensing elements to be dielectrically isolated from, while being molecularly attached to a silicon diaphragm (Figs. 2, 3). The process for fabricating the composite dielectrically isolated SOI sensor structure requires the use of two separate wafers. The first “Pattern” wafer is specifically selected to optimize the piezoresistive performance characteristics of the sensor chip, while the second “Substrate” wafer is specifically selected to optimize the micromachining

capabilities of the sensing diaphragm. A layer of the best thermally grown oxide is then grown on the surface of the substrate, while the piezoresistive patterns are diffused to the highest level (solid solubility) in order to achieve the most stable, long-term electrical performance characteristics of the sensing network. Once the pattern and the substrate wafers are fusion bonded together using a specifically developed and patented diffusion enhanced fusion technique. The resulting molecular bond between the two wafers is as strong as silicon itself, and since both the sensing elements and the diaphragm are made from the same material, there is no thermal mismatch between the two, thus resulting in very stable-accurate performance characteristics with temperature. The presence of dielectric isolation enables the sensor to function at very high temperatures without any leakage effects associated with the p-n junction type devices. Since the device is capable of operating at high temperatures, a high temperature metallization scheme is introduced to enable the device to interface with the header at these high temperatures as well.

The micromachining is performed using a combination of different wet (Isotropic and Anisotropic) chemical processes. The shape and performance characteristics of the micromachined-sensing diaphragm are modeled using finite element analysis at the initial design stage. All of Kulite's sensors contain a stiffening member (referred to as "boss") located in the middle of the sensing diaphragm. The boss acts as to stiffen and thus linearize the performance of the sensor. The shape of the boss is also modeled via finite element analysis. The composite silicon sensor is attached to a pyrex pedestal, by an electrostatic bonding program, to form a pressure-sensing capsule as shown in Fig. 3. If silicon is used, because of its superior Young Modulus, the height of the whole assembly may be reduced to as little as .010", although a figure of .015" is more typical.

The pedestal material is selected to thermally match the physical characteristics of the silicon sensor. Whenever the requirement exists, the pressure capsule incorporates an overpressure stop.

The sensing circuit is electrically insulated from the metallic housing by virtue of the non conductive pedestal in the pressure capsule.

The insulation resistance and the dielectric strength are inherently very high. The reference pressure is accomplished between the diaphragm and pedestal, providing a true hermetic seal.

As the diaphragm deflects under pressure, the resistances of the piezoresistive elements change in value causing the Wheatstone bridge network to move out-of-balance. The application of electrical excitation to this bridge (usually 5 V) produces a bridge output voltage proportional to the applied pressure (typically 100mV for maximum operating deflection). The sensitivity (units V/Pa) is termed the sensor span. Naturally, if the elements are of equal resistance, there will be a zero output voltage with no pressure differential across the diaphragm, although more usually there is some small voltage, termed the offset voltage. Both of these characteristics are determined by calibration.

In addition to the basic pressure sensitivity of the silicon-sensing device, three other sensitivities have been mentioned. The first of these, temperature sensitivity, is easily dealt with using temperature compensation schemes; (Ainsworth et al, 1991 [1]; Ainsworth et al, 2000 [2]; Epstein, 1985 [3] of which there are a great plethora. This arises as follows: the resistive impedance value of the piezoresistive elements depends not only on the strain they experience, but also their temperature for two reasons: the strain gage factor (change in resistance per unit of strain) of each element depends on the electrical properties of the p-type semiconductor created; and the element resistance itself (even in the absence strain) is also a function of temperature. Given that the output of the sensor is linear with applied pressure, these two effects change the values of sensor span and offset, and the variation with temperature of these values is termed span and offset sensitivity.

The second sensitivity, termed base strain sensitivity, is caused by strain transmitted into the sensor diaphragm from the underlying parent material on which the sensor is mounted. For instance, in the case of a turbine blade, a strain field will be set up in the surface of the blade due to rotation. It is the function of the strain-isolating pedestal in figure 3 to reduce the value of the strain induced in the diaphragm by this mechanism.

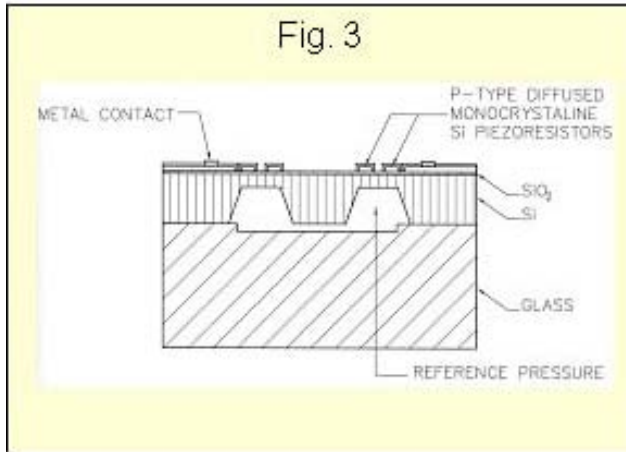

In any case, this effect can be calibrated, and is usually small enough to be neglected. Being more specific (Ainsworth et al, 2000 [3]), typical results for this kind of calibration gave a base strain sensitivity of -0.00164 %FS, the negative sign indicating a decreasing output with increasing tensile strain. In turn, this caused an error of -0.33 %FS for sensors mounted at mid-height on the rotor.

Table 1: Typical acceleration sensitivities for 'conventional' devices

NOMINAL SENSOR FULL-SCALE PRESSURE RATING (PSI)	25	50	100	250
Perpendicular sensor % nomin. F.S./g	2e-4	1.5e-4	1e-4	5e-5
Transverse sens. % nomin. F.S./g	4e-5	3e-5	2e-5	1e-5

The third sensitivity, acceleration sensitivity, is of course more significant in applications where either vibration levels are high, or high centrifugal accelerations are experienced. In aero elastic applications, there is currently interest in measuring unsteady pressure fields whilst blades are vibrating, excited by the aerodynamics. For the current generation of piezoresistive sensors, an inertial load experienced by the diaphragm would cause a deflection in that diaphragm, and hence an apparent pressure signal would be registered. The size of the effect depends on the acceleration experienced and the full-scale pressure range of the device (i.e. the stiffness of the diaphragm) and is tabulated in Table 1 for the typical sensor in use today.

While centrifugal accelerations in the turbine application are large, they are at least well quantified, and thus this effect may be allowed for in the data reduction process. Alternatively, sensors may be calibrated in situ if the rotor can be rotated in a vacuum. However, in the case of vibrating blades, the levels of acceleration experienced due to the vibration are not so easily quantified, since they will be mode and damping-dependent, and indeed more than one mode may be present at a given time. Clearly a pressure measuring device, which had no sensitivity to inertial forces, would be of significant interest to the experimentalist. The next section describes such a device.

### 3. Acceleration Insensitive Pressure Sensor

In essence, the device is a variant of the technology described earlier, except that the chip is produced using a "leadless" approach, and two stress-deflecting diaphragms mounted adjacently. On each diaphragm, a half Wheatstone bridge is formed using two piezoresistors in series. One piezoresistor of each pair increases in resistance with a positive normal stress to the plane of the diaphragm whilst the other decreases. The two diaphragms are both exposed to the inertial stresses (vibration and centrifugal acceleration induced), but only one is exposed to the pressure to be measured (see figures 4 and 5). The two half-bridges from each diaphragm are electrically coupled to form a full-bridge such that for a positive stress applied substantially normal to the diaphragm, the bridge output of one half-bridge will subtract from the other. Thus the signal output is responsive to the pressure as applied to one diaphragm while the signal response to inertial stresses (and indeed any stress other than that due to pressure) applied to both diaphragms is cancelled out.

Figure 4: Cross section of 'g-insensitive' pressure sensor, showing top cover, silicon wafer and bottom mounting pedestal

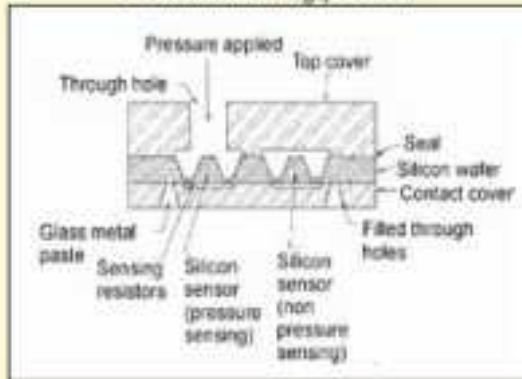
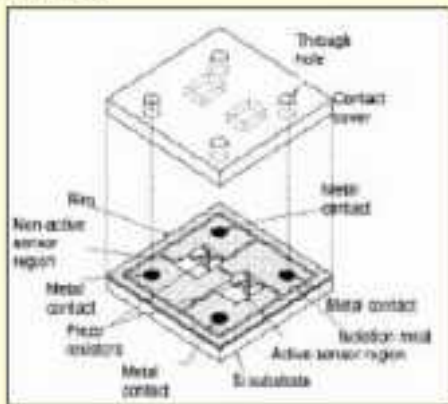

Figure 5: Silicon diaphragm showing piezoresistor sensor disposition, and contact cover by means of which sensor is mounted



Complete cancellation would be dependent on the two deflecting diaphragms having exactly the same size, thickness, with matching piezoresistive characteristics. The layout of the sensing diaphragm is shown in detail in figure 6, where the two independent half bridges can clearly be seen. In a normal sensor, two additional piezoresistors would be placed in the bottom half of the rectangular aperture, above the stress raising regions, created by the presence of the boss (see figure 7), forming the full Wheatstone bridge on one diaphragm. A Kulite patent, (Kurtz, 1999 [7]), describes in more detail, the fabrication of the particular device. In figure 4, shows that compared with earlier sensors, this "leadless" generation of device has the piezoresistors mounted underneath the diaphragm (away from the

Figure 6: Plan view of silicon chip showing the two adjacent active areas, one only of which is exposed to pressure.

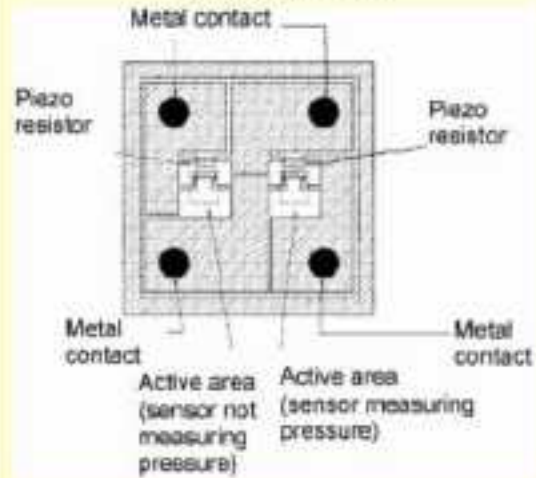
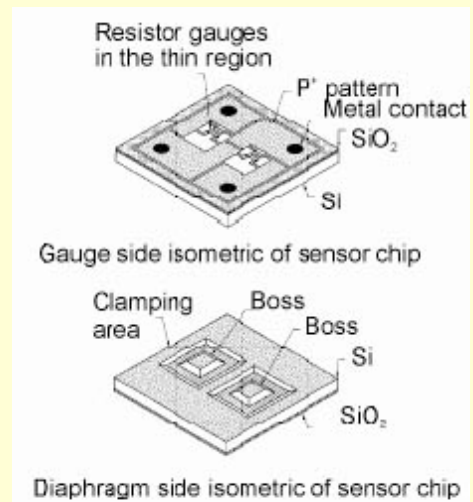

Figure 7: Isometric views of silicon chip showing piezoresistor side and etched diaphragm side



pressurized side) thus protecting them from exposure to corrosive gases. Additionally, electrical contacts to the diaphragm are made by means of the "filled through holes" which, are filled with an electrically conductive glass metal paste removing the need for the more conventional gold "ball-bond". This is seen as particularly advantageous in applications where levels of vibration are high, since the fine gold ball-bond wire is prone to failure at high vibratory levels. Again, this "leadless" technology (Kurtz at al, 2003 [8]) builds on earlier device

development (Kurtz et al, 1999b [6] and Kurtz et al 1976 [9]) and will allow the direct attachment of the sensor without the need for any additional connecting leads.

In the present context, the issues to be faced are:

- (i) can such a device be constructed?
- (ii) Does this concept work?
- (iii) Are the piezoresistive semiconductor coefficients sufficiently well matched between the two half bridges (albeit from adjacent portions of the original silicon wafer) to permit compensation for inertial stresses?
- (iv) Is the area of "land" between diaphragms sufficient to allow rejection of mechanical stress induced in one from affecting the other?

The answer to the first question was quickly provided by Kulite, where the device was produced within two months of the first discussions. In terms of the second, the normal environmental electrical calibrations were performed in Oxford (Ainsworth et al, 2000 [2]). The pressure and temperature sensitivities of six 'g-insensitive' sensors were investigated using a computer controlled environmental chamber. These experiments have enabled the measurement of the following sensor characteristics: span sensitivity, offset sensitivity, fractional slope sensitivity and the temperature coefficient of bridge resistance. The sensors were found to behave in a stable manner over a period of several months. In particular, the new form of electrical contact with the sensor diaphragm ("leadless") appeared to introduce no stability problems.

As far as verification of performance under inertial loadings, it was decided to conduct experiments in a spinning rig, described below.

#### 4. Experiments to Determine Sensor 'g' Sensitivity (Rotational Acceleration)

It was shown earlier in Table 1 that the sensitivity of a conventional piezoresistive pressure sensor to inertial loadings ('g sensitivity') is not large, and that careful experimentation was going to be required to determine whether this novel sensor design was actually working as intended. It was decided, therefore, to conduct a datum experiment simultaneously, such that the sensitivity to 'g' of a conventional device could be tested at the same time as the new design.

A schematic diagram of the spinning-rig test facility is shown in Figure 8, together with photographs of the rig in Figures 9 and 10. The spinning disk itself is shown in Figure 11. Briefly, the rig consisted of a disk that was rotated by an air-motor, a slip-ring assembly and a sealed containment tank. Services such as air-motor supply and electrical connections were provided through bulkheads. The air pressure within the tank could be varied from 0.02 to 2 atms. The disk had pockets that allowed instrumentation to be positioned close to its tip, with electrical connections being made via copper coated Kapton tracks and miniature wires that passed into the shaft of the rotating assembly (see Figure 9). Extension wires that lay along the axis of rotation connected the instrumentation to a 24 channel slip-ring.

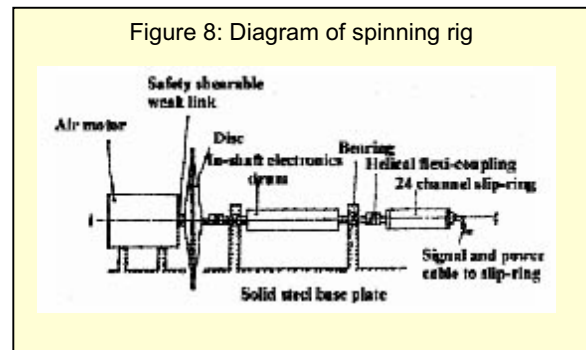

The stationary outputs of the slip-ring were connected through a bulkhead to the data acquisition equipment. Sensor output voltage and disk speed measurement signals were recorded by computer controlled Hewlett-Packard digital voltmeters at a sample rate of approximately 2 Hz. Run-time data was stored

in computer files that were interrogated post-run. A summary of the specification is provided in Table 2.

Table 2: A summary of the spinning-rig specification.

DISK DIAMETER	0.55	m
Maximum Rotational Speed	6000	rpm
Maximum Radial Acceleration	11000	g
Air Pressure Surrounding Disk	0.02 to 2	Bar absolute
Slip-Ring Channels	24	-

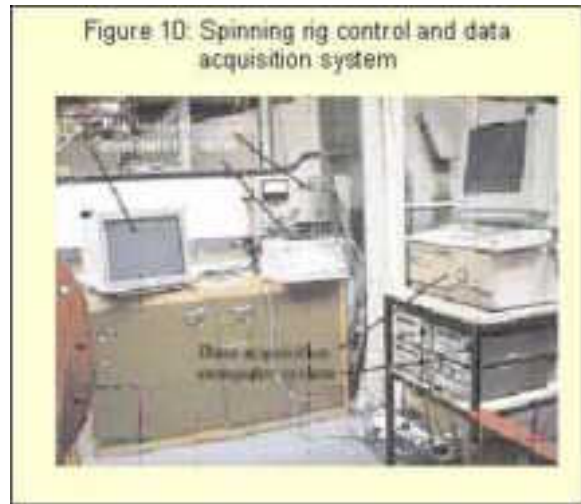

A photograph of the location and orientation of the test-sensors is shown in Figure 12. The back surface of the sensors was bonded to a solid surface within the instrumentation pocket. In this configuration, the radial acceleration of the sensors was normal to the sensors to rotating machinery; this mode would represent a worst-case scenario for acceleration effects.

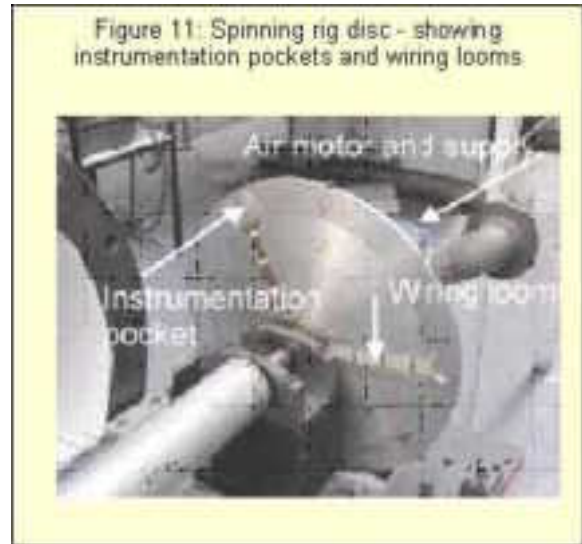

In order to decouple the effects of acceleration and pressure on the transducer output, testing was conducted with low air pressure inside the sealed tank. Experience had indicated that operating at an absolute pressure below 6.6 kPa was sufficient to reduce churning effects within the tank to acceptable levels.

#### 4.1 Experimental Results



A typical rotational speed history for a spinning-rig test is shown in Figure 13. The total test duration is approximately 3 minutes, during which time the disk is accelerated from rest to 4000 rpm and then allowed to coast back to rest. The sensor output voltage data are continuously acquired at rate of approximately 2 Hz and this data is subsequently analyzed to establish the characteristic 'output versus g' plot for each sensor.

## 4.2 Piezoresistive Pressure Sensor Results

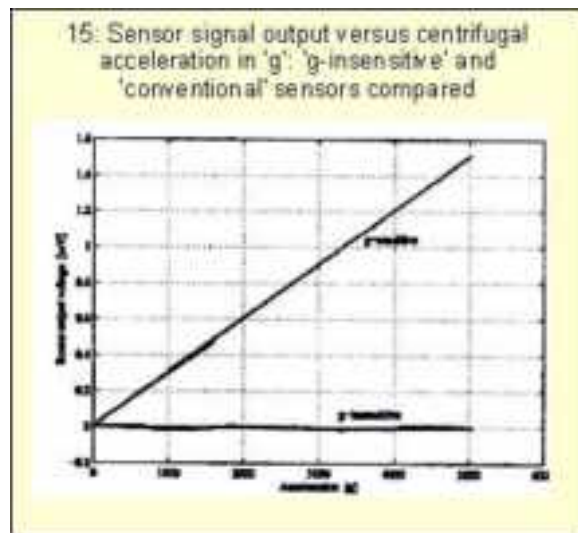
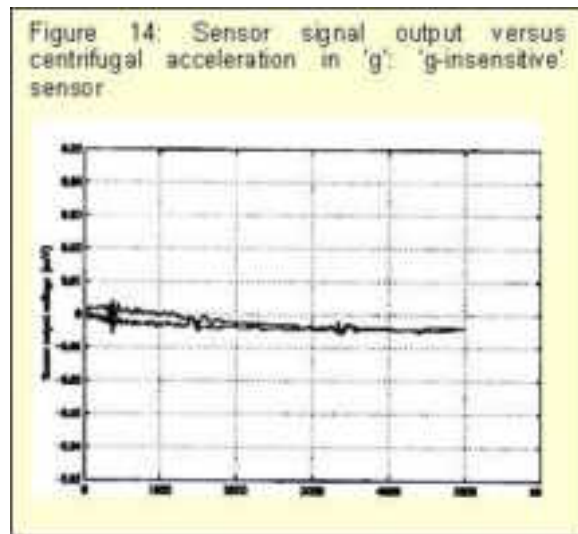
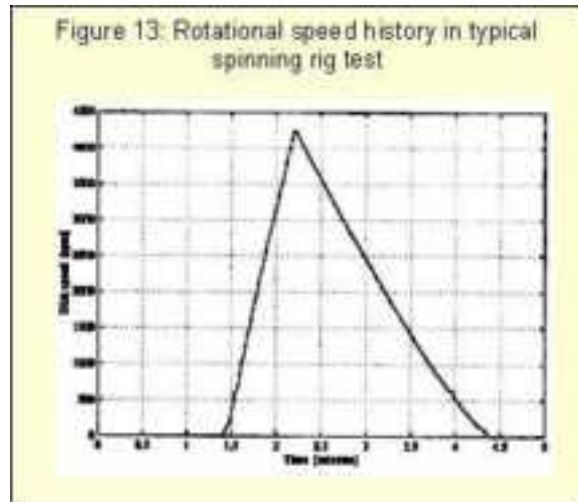

A measurement campaign was conducted over

a period of time with two sensors mounted in the instrumentation pocket simultaneously. The two were of differing types – a 'conventional' sensor and a 'g-insensitive' variant. The idea of this was to allow direct comparison of the output of the two devices under near identical experimental conditions. The 'conventional' device itself was of the 'leadless' type, and thus its diaphragm size and construction was to an extent, similar to those in the 'g-insensitive type'. A typical graph of sensor output voltage plotted as a function of acceleration for the 'g-insensitive' sensor (Kulite id. Number 3) is shown in Figure 14. This test was conducted at a rig pressure of 5 kPa, being the environmental pressure which could be reached in a reasonable period of time of vacuum pump operation. Note that the offset voltage at this pressure has been subtracted from all the data points. The data exhibits an excellent signal to noise ratio and was obtained at a resolution of 1  $\mu\text{V}$ . as can be seen in the graph, the maximum change in voltage during the test is  $\sim 0.4$  mV in the acceleration sensitivity of approximately  $1 \times 10^{-6}$  % of full-scale per g. Data was simultaneously recorded from a 'conventional' sensor (Kulite id. Number 41) and the data from the 'conventional' sensor shows a linear relationship between sensor output voltage and acceleration. The acceleration sensitivity is  $4 \times 10^{-4}$  % full-scale per g, which, bearing in mind the differences in detail of construction is in close agreement with figures quoted in Kulite literature and given in Table 1. The corresponding data for the 'g-insensitive' sensor when plotted on this same scale clearly shows the dramatic reduction in acceleration sensitivity associated with this new device. It should be borne in mind that high fidelity of data acquisition was required to conduct this experiment. Confidences in acquired voltages down to the low microvolt level were required and any electromagnetic pick-up would have obscured the result. Being specific, the pressure sensing devices under test had a full-scale output of 100 mV at 25 psi (1.7 bar), thus the resolution of voltage at 1  $\mu\text{V}$  was equivalent to 1.7 Pa. It was pleasing to be able to have a 'control' experiment running simultaneously, in terms of taking data from a 'conventional' sensor.

A campaign of measurements over a period of time was conducted, using a number of different sensors, but they all displayed the pattern of behavior outlined above.



## 5. Experiment to Determine Sensor 'g'-sensitivity (Vibration Acceleration)

It is frequently required to obtain data on structures subjected to high vibration levels as well as high temperatures, and it was thought that the acceleration compensated chip would be ideal for this application. Therefore, a new acceleration compensated, high temperature, thin line transducer was designed. The resulting transducer is suitable for measuring pressures at temperatures in excess of 500°F and the structure is such that the entire device can be welded onto the structure to be measured. In order to evaluate the new devices, Kulite has developed and established its own testing and evaluation technology. Using standard vibration test apparatus, accelerations to 50Gs can be achieved, in the 100 Hz to 3000 Hz range. In order to test components to significantly higher G levels, a resonant beam apparatus is used to achieve the high acceleration levels on standard vibration test equipment.

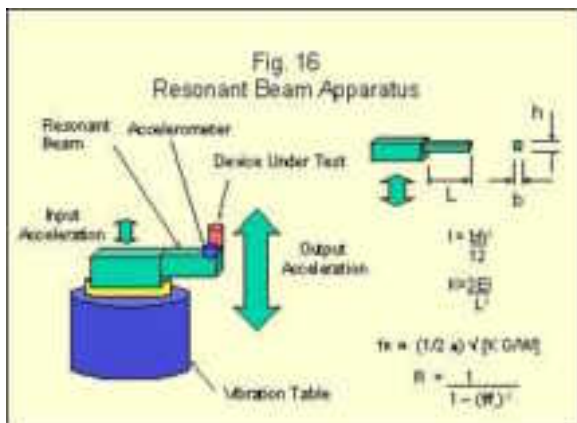

The beam is designed (Fig. 16) to amplify the acceleration level around the beam's resonant frequency with an amplification essentially being the Q of the system. The resonant frequency is chosen based on design requirements at the high acceleration level. Typically, aircraft structures have the highest G requirements at about 1,000 Hz and the beam dimensions, such as length and cross section, are selected to achieve the frequency and amplification required. The beam is fastened to the vibration table (figs. 17, 18), allowing the low acceleration



levels to act as the system input. The device under test, which will experience the amplified G level, is placed at the end of the beam with an accelerometer.

(fig19)

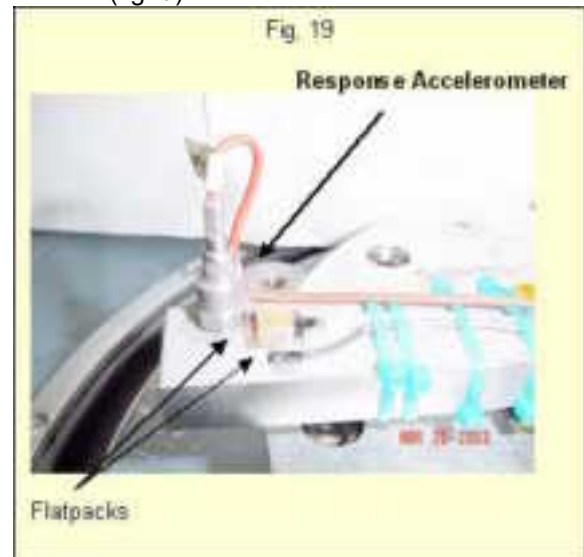

The amplification (Q) can be on the order of 10 to 250. The acceleration compensated chip was mounted into high temperature flatpack (fig. 20), where the electrical connections were made to a specifically designed high temperature interconnect board using high temperature glass frit as a contact material. The contacts were established at the same time as the chip was mounted onto the interconnect board with a non-conductive glass frit. Both conductive and non-conductive frits are designed to fire at the same time. Once the interconnections between the chip and the lead outs on the flatpack are established, the flatpack is sealed with a cover and is ready for testing (fig. 21).

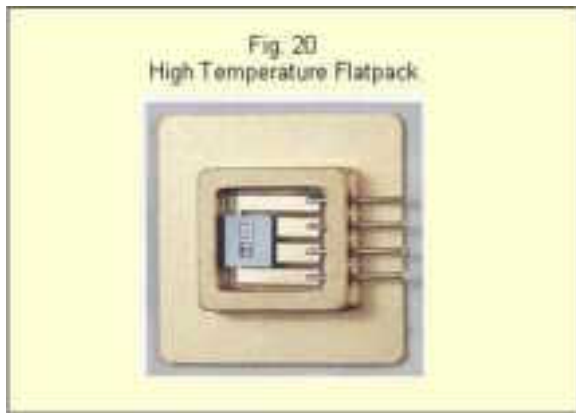

### 5.1 Piezoresistor Sensor Results

Using the high G resonant beam apparatus, both the g-insensitive and standard leadless flatpacks were vibrated at approximately 1,000 G for 10 minutes with no failures. Thus, both the g-insensitive and the standard leadless flatpacks

functioned well under high vibration environments. The important result is that the units were subjected to a true dynamic vibration (acceleration), where the g-levels fluctuated very rapidly and both units (types) performed well. Since the standard unit's g-sensitivity is low, an insignificant response to vibration in both units was expected. The g-insensitive unit, however, does appear to perform better than a standard leadless unit, even under vibration (acceleration) (fig. 22). The g-insensitive unit exhibited approximately a 10:1 reduction in sensitivity to vibration as compared to the standard leadless unit.

### Conclusion

The latest generation of leadless sensors have been designed, fabricated and evaluated within Kulite with very encouraging results. The key features of the g-insensitive leadless design (protected by U.S. Patent Number 6,293,154) are: 1) the leadless transducer assembly which will enable these transducers to operate reliably in the most hostile environments and 2) the use of two stress-deflecting diaphragms mounted adjacently on the leadless chip in such a way as to produce a single g-sensitive output.

The latest generation of high temperature g-insensitive sensors has been additionally evaluated under high vibration to simulate real dynamic application of rapid G-level changes. Unlike the rotational acceleration, the vibrational acceleration introduces a component of true dynamics and survivability into the equation. All of the units survived the high G-level vibration without any signs of degradation and in fact,

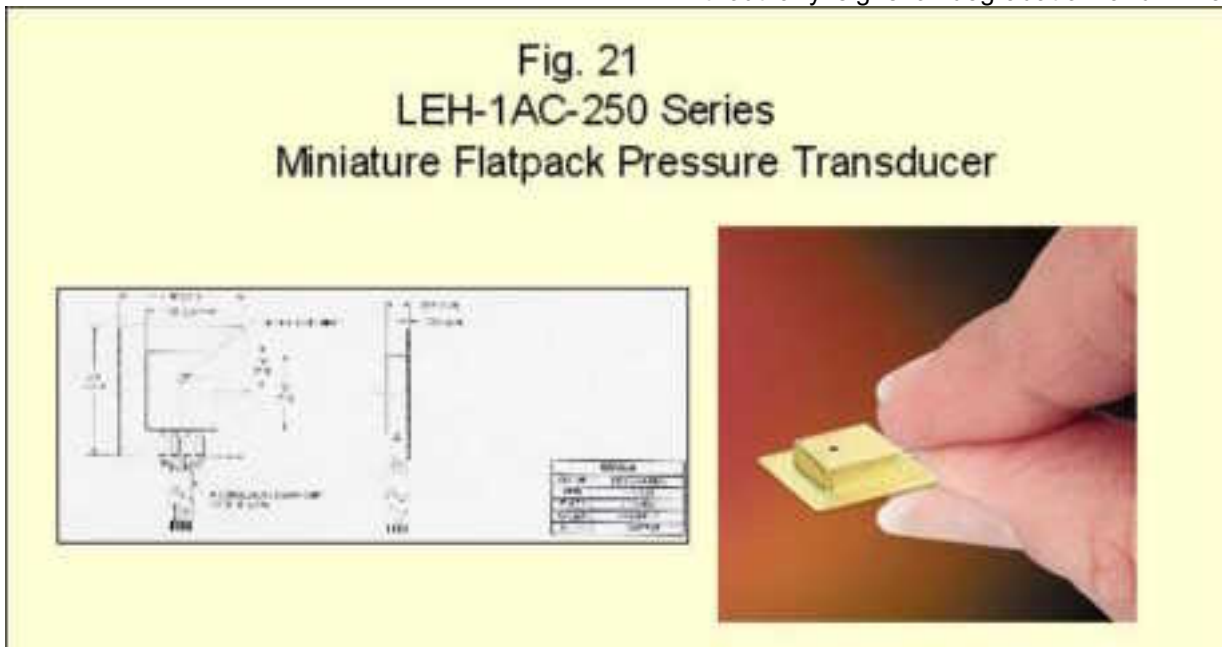

performed significantly superior to the standard leadless units. It can now be stated that the g-insensitive chips are excellent candidates for pressure measurements in environments with high acceleration (vibration or rotation) as well as high temperature.

Currently these second-generation leadless high temperature g-insensitive dynamic pressure transducers are being evaluated both in

laboratories and on gas turbines by the majority of the US and European aero engine manufacturers and many aerospace industry test organizations. The results of this test program will be the subject of further technical papers.

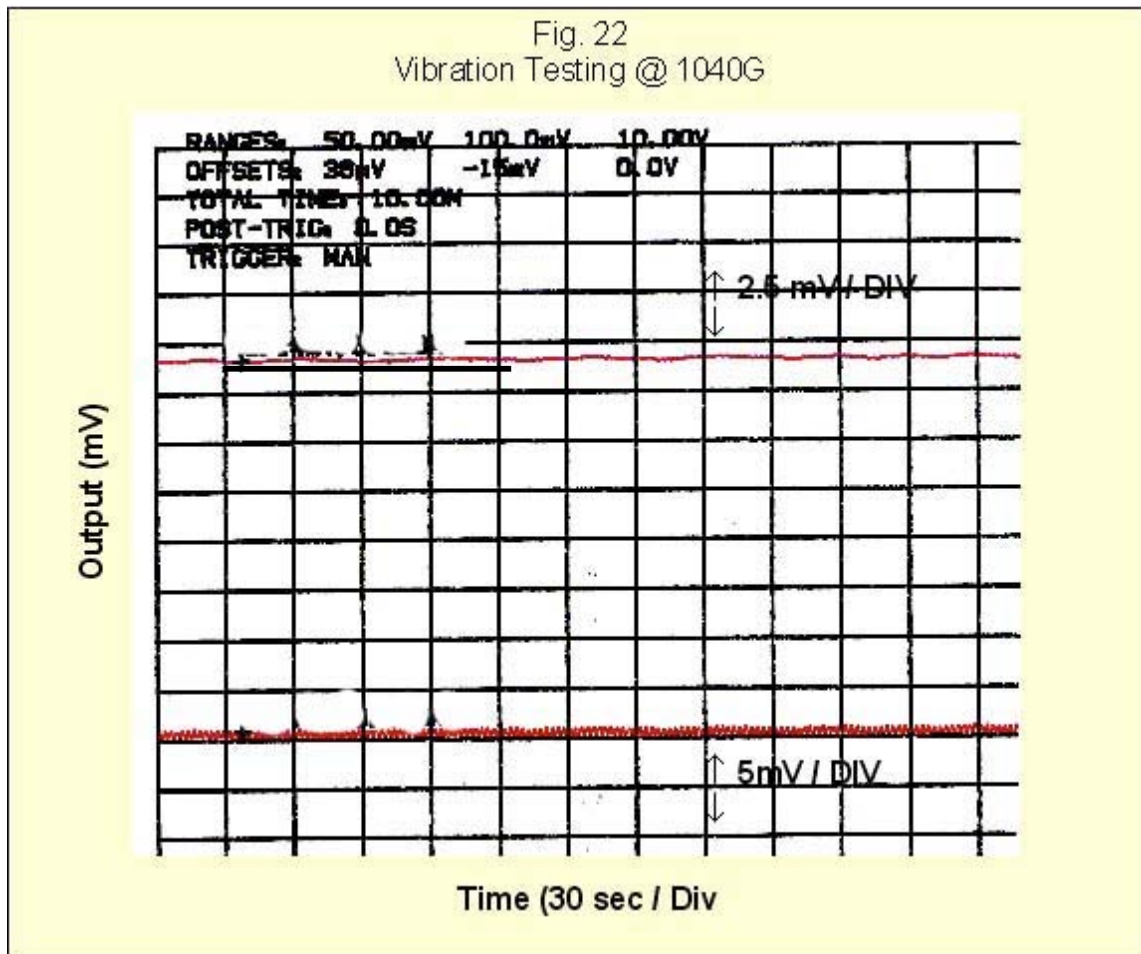

## 7. References

1. Ainsworth, R.W., Dietz, A.J., and Nunn, T.A., 1991, "The Use of Semiconductor Sensors for Blade Surface Pressure Measurement", Journal of Eng. For Gas Turbines and Power, vol 113, p159.
2. Ainsworth, R.W., Miller, R.J., Moss R.W., and Thorpe, S.J., 2000, "Unsteady Pressure Measurement", Meas. Sci. Technol. **11** pp1055-1076.
3. Epstein, A.L., 1985, "High Frequency Response Measurements in Turbomachinery", VKI Lecture Series 1985-03, Brussels.
4. Kurtz, A.D., and Mallon, J.R., 1976, "High Temperature Transducers and Housing including Fabrication Methods", U.S. Patent number 3930823.
5. Kurtz, A.D., and Ned, A.A., 1999b, "Sensors for Use in High Vibrational Applications and Methods for Fabricating Same", U.S. Patent number 5955771.
6. A.D. Kurtz 1999a U.S. Patent #6,293,154 "Vibration Compensated Pressured Sensing Assembly", issued to Kulite Semiconductor Products, Inc., Leonia, NJ 9/25/01.
7. A.D. Kurtz, A. Ned, S. Goodman, A. Epstein, "Latest Ruggedized High Temperature Piezoresistor Transducers", Kulite Semiconductor Products, Inc., Leonia, NJ.

Kulite Semiconductor Products, Inc.  
Presented at the NASA 2003 Propulsion Measurement Sensor Development Workshop  
Huntsville Alabama May 13-15 2003